



OUTBOARD MOTOR

OWNER'S MANUAL

F2.6BM

SUZHOU PARSUN POWER MACHINE CO., LTD.

Thank you for owning a PARSUN outboard motor.

Thank you for your trust in our company and products.

- “PARSUN” outboard motors are powerful, economic and safe with advanced technology and processing technique.
- Please read this manual carefully before operating your outboard motor. A thorough understanding of the manual will help you to know this product for proper operation, maintenance and care. This will ensure that your outboard motor is operated well under various conditions.
- “PARSUN” seeks continuous improvement in product quality. Therefore, while this manual contains the most current product information available at the time of printing, there may be minor discrepancies between your machine and this manual. If there is any question concerning the manual, please consult your local PARSUN dealer.
- Data, illustrations or explanations in this Owner’s Manual do not constitute base for any legal claim against our company.

SUZHOU PARSUN POWER MACHINE CO., LTD

Engine serial number

The engine serial number is carved on the aluminum casting of engine.



Serial number as follows:

--	--	--	--	--	--	--	--	--	--	--	--	--	--	--	--	--	--	--	--

Manufacturer's Declaration

This outboard motor complies with the requirements of Directive 2003/44/EC in relation to the exhaust and noise emissions. The following installation and maintenance instructions, if applied, guarantee that the outboard motor will remain in compliance with:

1. Exhaust emissions limits throughout the normal life or the engine (350 hours or 10 years, whichever occurs first) and under normal conditions of use.
2. Noise emissions limits under normal conditions of use.

Table of contents

1.	Main components and General information.....	1
1.1.	Main components.....	1
1.2.	General information.....	3
1.2.1.	Specifications.....	3
1.2.2.	Fueling instructions.....	4
1.2.3.	Propeller selection.....	5
2.	Operation.....	6
2.1	Installation.....	6
2.1.1.	Mounting height.....	7
2.1.2.	Clamping the outboard motor.....	9
2.2	Breaking in engine.....	9
2.3	Pre-operation checks.....	10
2.4	Filling fuel.....	12
2.5	Starting engine.....	13
2.6	Warming up engine.....	16
2.7	Shifting.....	18
2.7.1.	Forward.....	18
2.7.2.	Reverse.....	19

2.8	Tiller.....	20
2.9	Stopping engine.....	22
2.10	Trimming outboard motor.....	23
2.11	Tilting up and down.....	24
2.11.1.	Tilting up.....	24
2.11.2.	Tilting down.....	26
2.12	Cruising in other conditions.....	27
2.12.1.	Cruising in shallow water.....	27
2.12.2.	Cruising in salt water.....	28
3.	Maintenance.....	29
3.1	Greasing.....	29
3.2	Cleaning and adjusting spark plug.....	30
3.3	Checking fuel system.....	30
3.4	Inspecting idling speed.....	31
3.5	Changing engine oil.....	31
3.6	Checking wiring and connectors.....	33
3.7	Checking for leakage.....	33
3.8	Checking propeller.....	34
3.8.1.	Removing the propeller.....	35
3.8.2.	Installing the propeller.....	35
3.9	Changing gear oil.....	36

3.10	Cleaning fuel tank.....	37
3.11	Checking and replacing anode(s).....	38
3.12	Checking top cowling.....	38
3.13	Maintenance table.....	39
4.	Transporting and storing outboard motor.....	41
4.1	Transporting.....	41
4.2	Storing.....	42
5.	Action in emergency.....	44
5.1	Impact damage.....	44
5.2	Starter will not operate.....	44
5.3	Treatment of submerged motor.....	48
6.	Troubleshooting.....	50
7.	Circuit diagram	54

1. Main components and General information

1.1 Main components

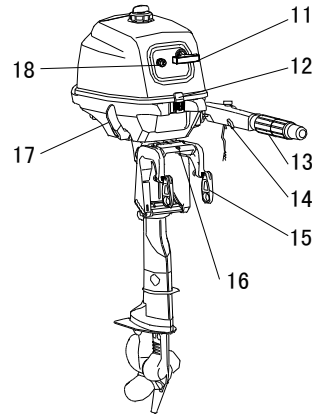
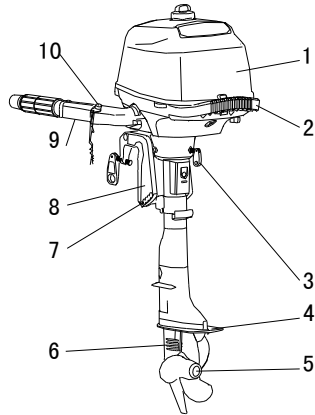

1.Top cowling

2.Carrying handle

3.Steering friction screw

4.Anti-cavitation plate

5.Propeller

6.Cooling water inlet

7.Trim rod

8.Clamp bracket

9.Tiller handle

10.Engine stop button/

Engine stop lanyard switch

11.Starter handle

12.Top cowling lock levers

13.Throttle friction adjuster

14.Throttle grip

15.Clamp screw

16.Rope attachment

17.Gear shift lever

18.Choke knob

Your model includes a built-in fuel tank, its parts are as follows:

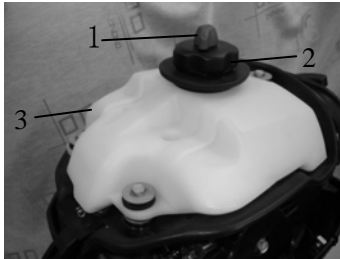

- 1. Air vent screw
- 2. Fuel tank cap



- 3. Built-in fuel tank
- 4. Fuel cock (close position)

⚠ WARNING

The fuel tank supplied with this engine could only be used as supply of fuel for its running and must not be as a fuel storage container.

1.2 General information

1.2.1 Specifications

Parameter

Items	Data	Items	Data
Type of engine	4-stroke S	Recommended fuel	Unleaded regular gasoline
Displacement	72cm ³	Built-in fuel tank capacity	1.2L
Bore X stroke	54.0mm×31.5mm	Recommended engine oil	SAE10W30 or SAE10W40
Gear ratio	2.08 (27/13)	Engine oil quantity	0.35L
Overall length	645mm	Recommended gear oil	Hypoid gear oil SAE # 90
Overall width	343mm	Gear oil quantity	75cm ³
Overall height(S/L)	1013/1140mm	Spark plug	BR6HS
Weight(S/L)	17/18Kg	Spark plug gap	0.6 ~ 0.7mm
Transom height(S/L)	381/508mm		

Performance

Items	Data	Items	Data
Maximum output	1.9Kw/5500Rpm (2.6HP)	Valve clearance IN (cold engine)	0.08 ~ 0.12mm
Full throttle operating range	5250 ~ 5750Rpm	Valve clearance EX (cold engine)	0.08 ~ 0.12mm
Idling speed (in neutral)	1900±100Rpm	Tightening Torque for engine	Spark plug
			Engine oil drain bolt
			25.0Nm
			18.0Nm

1.2.2 Fueling instructions

Fueling instructions:

Recommended gasoline:
Regular unleaded gasoline, If it is not available,
then premium gasoline.

If knocking or pinging occurs, use a different brand of gasoline or premium unleaded fuel. If leaded gasoline is usually used, engine valves and related parts should be inspected after every 100 hours of operation.

 **WARNING:**

- Do not smoke when refueling, and keep away from sparks, flames, or other sources of ignition.
- Stop engine before refueling.
- Refuel in a well-ventilated area. Refuel portable fuel tanks off the boat.
- Do not overfill the fuel tank.
- Take care not to spill gasoline, if gasoline spills, wipe it up immediately.
- Tighten the filler cap securely after refueling.
- If you should swallow some gasoline, inhale a lot of gasoline vapor, or get gasoline in your eye, get immediate medical attentions.
- If any gasoline spills onto your skin, immediately wash with soap and water. Change clothing if gasoline spills on it.
- Touch the fuel nozzle to metal components to prevent electrostatic sparks.

CAUTION:

Use only new clean gasoline which has been stored in clean containers and is not contaminated with water or foreign matter.

Engine oil:

Recommended engine oil: 4-stroke outboard motor oil SAE10W30 and SAE10W40 (0.35L).

 **WARNING:**

- Do not start the engine when the oil level is low. Serious damage might occur.
- Always check the oil level before starting the engine.

CAUTION:

All 4-stroke engines are shipped from the factory without engine oil.

1.2.3 Propeller selection

The performance of your outboard motor will be critically affected by your choice of propeller, as an incorrect choice could adversely affect performance. The outboard motor is fitted with propellers chosen to perform well over a range of applications, but there may be uses where a propeller with a different pitch would be more appropriate. "PARSUN" dealers stock a range of propellers and can advise you and install a propeller on your outboard that is best suited to your application.

For a greater boat load and a low engine speed, a smaller-pitch propeller is more suitable. Conversely, A large-pitch propeller is more suitable for a smaller operating load as it enables the correct engine speed to be maintained.

2 Operation

2.1 Installation

Mount the outboard motor on the center line (keel line) of the boat. For boats without a keel or which are asymmetrical, consult your dealer.

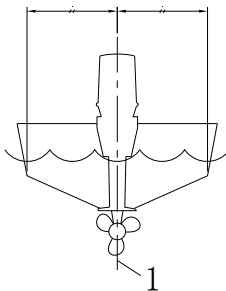

1. center line (keel line)

NOTE:

During water testing check the buoyancy of the boat, at rest, with its maximum load. Check that the static water level on the exhaust housing is low enough to prevent water entry into the power head, when water rises due to waves when the outboard is not running.

⚠ WARNING:

- **Overpowering a boat could cause severe instability. Do not install an outboard motor with more horsepower than the maximum rating on the capacity plate of the boat. If the boat does not have a capacity plate, consult the boat manufacturer.**

- **Improper mounting of the outboard motor could result in hazardous conditions. For permanently mounted models, your dealer or other person experienced in proper rigging should mount the motor. If you are mounting the motor yourself, you should be trained by an experienced person. For portable models, your dealer or other person experienced in proper outboard motor mounting should show you how to mount your motor.**
- **The information presented in this section is intended as reference only. Proper mounting depends in part on experience and the specific boat and motor combination.**

2.1.1 Mounting height

The mounting height of the outboard motor greatly affects your boat running efficiency. If the mounting height is too high, cavitation tends to occur, thus reducing the propulsion. If the mounting height is too low, the water resistance will increase and thereby reduce engine efficiency. Mount the outboard motor so that the anti-cavitation plate is between the bottom of the boat and a level 25mm below it.

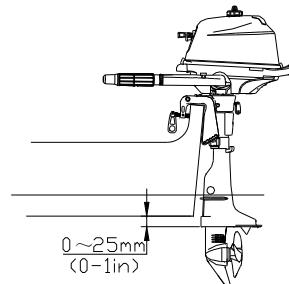

NOTE:

The optimum mounting height of the outboard motor is affected by the boat and motor combination and the desired use. Test runs at a different height can help determine the optimum mounting height. For further information, consult your “PARSUN” dealer or boat manufacturer.

2.1.2 Clamping the outboard motor

1. Tighten the transom clamp screw evenly and securely. Occasionally check the clamp screws for tightness during operation of the outboard motor because they could become loose due to engine vibration.



⚠ WARNING:

- Loose clamp screws could allow the outboard motor to fall off or move on the transom. This could cause loss of control.
- Make sure the clamp screws are tightened securely. Occasionally check the screws for tightness during operation.

2. If the engine restraint cable attachment is equipped on your engine, an engine restraint cable or chain should be used. Attach to a secure mounting point on the boat to avoid the engine being completely lost if it accidentally falls off the transom.



3. Secure the clamp bracket to the transom using the appropriate bolts. For details, consult your PARSUN dealer.

⚠ WARNING:

Avoid using bolts, nuts or washers inappropriate. After tightening, test running the engine and check their tightness.

2.2 Breaking in engine

Your new engine requires a period of break-in to allow mating surfaces of moving parts to wear in evenly.

CAUTION:

Failure to follow the break-in procedure could result in reduced engine life or even severe engine damage.

1. For the first hour of operation:

Run the engine at 2000 r/min or at approximately half throttle.

2. For the second hour of operation:

Run the engine at 3000 r/min or at approximately three-quarter throttle.

3. For the next eight hours of operation:

Avoid continuous operation at full throttle for more than five minutes at a time.

4. Operate the engine normally.

2.3 Pre-operation checks

Fuel

- Check to be sure you have plenty of fuel for your trip.
- Make sure there are no fuel leaks or gasoline fumes.
- Check fuel line connections to be sure they are tight.
- Be sure the fuel tank is positioned on a secure, flat surface, and that the fuel line is not twisted or flattened, or likely to contact sharp objects.

Controls

- Check throttle, shift and steering for proper operation before starting the engine.
- The controls should work smoothly, without binding or unusual free play.
- Look for loose or damaged connections.
- Check operation of the starter and stop switches when the outboard motor is in the water.

Engine

- Check the engine and engine mounting.
- Look for loose or damaged fasteners.
- Check the propeller for damage.

Checking the engine oil level

1. Put the outboard motor in an upright position (not tilted).

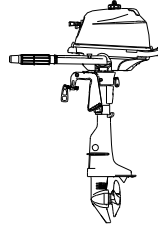

2. Check the oil level using the oil level check window to be sure the level falls between the upper and lower marks. Fill with oil if it is below the lower mark, or drain to the specified level if it is above the upper mark.



1.oil level check window

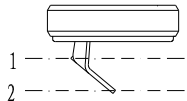

1. Upper level mark
2. Lower level mark

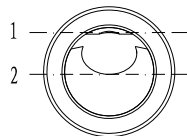

⚠ WARNING:

If any item in the pre-operation check is not working properly, have it inspected and repaired before operating the outboard motor. Otherwise an accident could occur.

CAUTION:

Do not start the engine out of water. Overheating and serious engine damage can occur.

2.4 Filling fuel

⚠ WARNING:

Gasoline and its vapors are highly flammable and explosive. Keep away from sparks, cigarettes, flames, or other sources of ignition.

1. Remove the fuel tank cap.
2. Carefully fill the fuel tank.

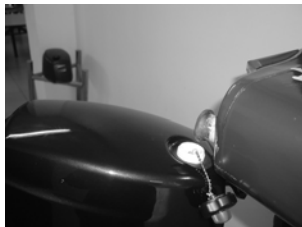

3. Securely close the cap after filling the tank. Wipe up any spilled fuel.

2.5 Starting engine

1. Loosen the air vent screw on the fuel tank cap.
One turn for built-in tank.



2. Open the fuel cock.



3. Place the gear shift lever in neutral.



NOTE:

Attach the engine stop switch lanyard to secure place on your clothing, or your arm or leg. Then install the lock plate on the other end of the lanyard into the engine stop switch.

⚠ WARNING:

- The engine must be started in neutral otherwise damage to the starter can occur.
- Do not attach the lanyard to clothing that could tear loose. Do not route the lanyard where it could become entangled, preventing it from functioning.
- Avoid accidentally pulling the lanyard during normal operation. Loss of engine power means the loss of steering control. Also, without engine power, the boat could slow rapidly. This could cause people and objects in the boat to be thrown forward.



4. Place the throttle grip in the “START” (start) position.



5. Pull out the choke knob fully.



NOTE:

- It is not necessary to use the choke when starting a warm engine.
- If the choke is left in the “START” (start) position while the engine is running, the engine will run poorly or stall.

6. Pull the manual starter handle slowly until you feel resistance. Then give a strong pull straight to crank and start the engine. Repeat if necessary.

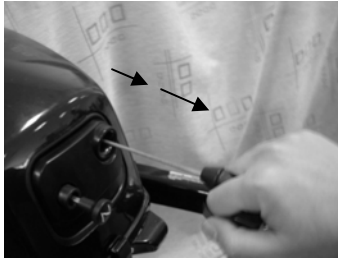

7. After the engine starts, slowly return the manual starter handle to its original position before releasing it.
8. Slowly return the throttle grip to the fully closed position.

CAUTION:

- **When the engine is cold, it needs to be warmed up.**
- **If the engine does not start on the first try, repeat the procedure. If the engine fails to start after 4 or 5 tries, open the throttle a small amount (between 1/8 and 1/4), and try again.**

2.6 Warming up engine

1. After starting the engine, return the choke knob to the halfway position. For approximately the first 5 minutes after starting, warm up the engine by operating at one fifth throttle or less. After the engine has warmed up, push the choke knob in fully.

CAUTION:

- If the choke knob is left pulled out after the engine starts, the engine will stall.
- In the temperatures of -5°C or less, leave the choke knob pulled out fully for approximately 30 seconds after starting.

2. Check for steady flow of water from the cooling water pilot hole.



CAUTION:

- If water is not flowing out of the hole at all times while the engine is running, stop the engine and check whether the cooling water inlet on the lower case or the cooling water pilot hole is blocked.
- If the problem cannot be located and corrected, consult your PARSUN dealer.

2.7 Shifting

⚠ WARNING:

Before shifting, make sure there are no swimmers or obstacles in the water near you.

CAUTION:

To shift from forward to reverse or vice versa, first close the throttle so that the engine idles (or runs at low speeds).

2.7.1 Forward

1. Place the throttle grip in the fully closed position.

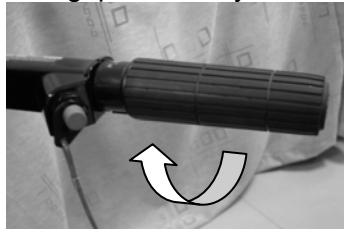

2. Move the gear shift lever quickly and firmly from neutral to forward.



2.7.2 Reverse

⚠ WARNING:

When operating in reverse, go slowly. Do not open the throttle more than half. Otherwise the boat could become unstable, which could result in loss of control and an accident.

1. Place the throttle trip in the fully closed position.

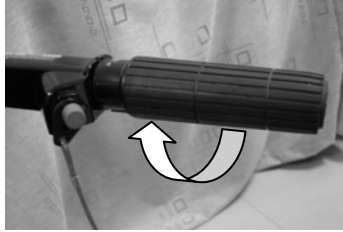

2. Turning the outboard motor around 180°.
3. Move the gear shift lever quickly and firmly from neutral to reverse.



NOTE:

The outboard motor can turn 360° in its bracket (full-pivot system). The boat can also be backed up by simply turning the outboard motor around 180° with the steering handle facing toward you.

2.8 Tiller

1. Change direction

To change direction, move the tiller handle to the left or right as necessary.

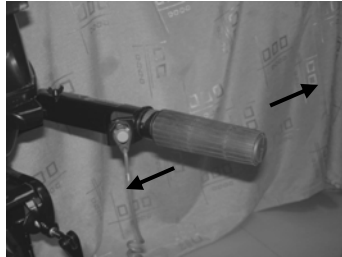

2. Change speed

Turn the grip counterclockwise to increase speed and clockwise to decrease speed.

3. Throttle indicator

The throttle indicator is on the throttle grip. The fuel consumption curve on the throttle indicator shows the relative amount of fuel consumed for each throttle position.

Choose the setting that offers the best performance and fuel economy for the desired operation.

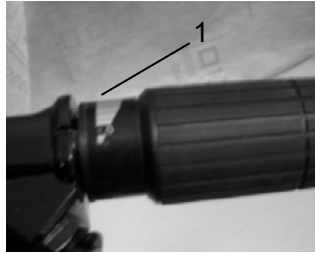

1.Throttle indicator

4. Throttle friction adjuster

The throttle friction adjuster is on the tiller handle, which provides adjustable resistance to movement of the throttle grip, and can be set according to operator preference. To increase resistance, turn the adjuster clockwise. To decrease resistance, turn the adjuster counterclockwise. When constant speed is desired, tighten the adjuster to maintain the desired throttle setting.



⚠️ WARNING:

Do not over-tighten the friction adjuster. If there is too much resistance, it could be difficult to move throttle lever or grip, which could result in an accident.

2.9 Stopping engine

NOTE:

Before stopping the engine, first let it cool off for a few minutes at idle or low speed. Stopping the engine immediately after operating at high speed is not recommended.

PROCEDURE:

1. Push and hold the engine stop button until the engine comes to a complete stop.

NOTE:

If the outboard motor is equipped with an engine stop switch lanyard, the engine can also be stopped by pulling the lanyard and removing the lock plate from the engine stop switch.



2. Tighten the air vent screw on the fuel tank cap and set the fuel cock lever or knob to the closed position.

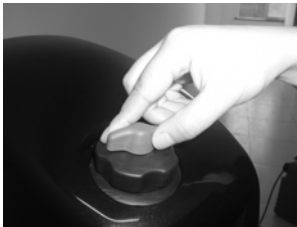

2.10 Trimming outboard motor

There are 4 or 5 holes provided in the clamp bracket to adjust the outboard motor trim angle.

1. Stop the engine.
2. Remove the trim rod from the clamp bracket while slightly tilting the outboard motor up.

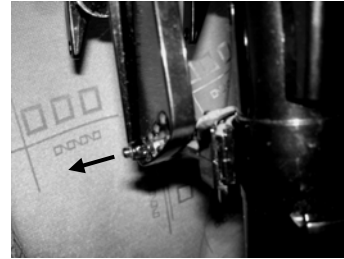

3. Reposition the rod in the desired hole. Make test runs with the trim set to different angles to find the position that works best for your boat and operating conditions.

⚠ WARNING:

- Stop the engine before adjusting the trim angle.
- Use care to avoid being pinched when removing or installing the rod.
- Use caution when trying a trim position for the first time. Increase speed gradually and watch for any signs of instability or control problems. Improper trim angle can cause loss of control.

2.11 Tilting up and down

If the engine will be stopped for some time or if the boat is moored in shallows, the outboard motor should be tilted up to protect the propeller and casing from damaged by collision with obstructions, and also to reduce corrosion.

⚠ WARNING:

- Be sure all people are clear of the outboard motor when tilting up and down, also be careful not to pinch any body parts between the drive unit and engine bracket.
- Tighten the air vent screw and place the fuel cock in the closed position if the outboard motor will be tilted for more than a few minutes. Otherwise fuel may leak.

NOTE:

- Do not tilt up the engine by pushing the tiller handle because this could break the handle.
- The outboard motor cannot be tilted when in reverse or when the outboard motor is turn 180° (facing the rear).

2.11.1 Tilting up

1. Place the gear shift lever in neutral (if equipped) and face the outboard motor forward.



2. Tighten the steering friction adjuster by turning it clockwise to prevent the motor from turning freely.

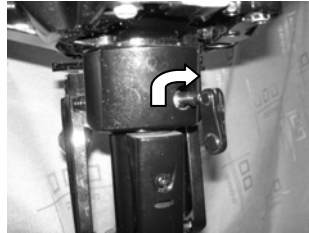

3. Tighten the air vent screw.



4. Close the fuel cock.



5. Hold the rear handle and tilt the engine up fully until the tilt support lever automatically locks.

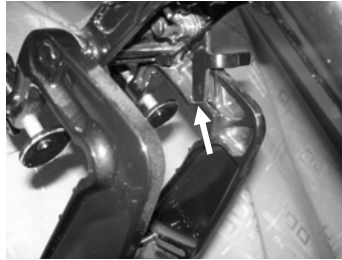

2.11.2 Tilting down

1. Slightly tilt the outboard motor up.
2. Slowly tilt the outboard motor down while pulling the tilt support bar lever up.



3. Loosen the steering friction adjuster by turning it counterclockwise, and adjust the steering friction according to operator preference.



⚠ WARNING:

If there is too much resistance it could be difficult to steer, which could result in an accident.

2.12 Cruising in other conditions

2.12.1 Cruising in shallow water

The outboard motor can be tilted up partially to allow operation in shallow water.

⚠ WARNING:

- **The tilt lock mechanism does not work while the shallow water cruising system is being used. Run the boat at the lowest possible speed to avoid the outboard motor being lifted out of the water, resulting in loss of control.**
- **Return the outboard motor to its normal position as soon as the boat is back in deeper water.**

CAUTION:

The cooling water inlet on the lower unit should be not above the surface of the water when setting up for and cruising in shallow water. Otherwise severe damage from overheating can result. For tilting procedure, see section 2.11.

2.12.2 Cruising in salt water

After operating in salt water, wash out the cooling water passages with fresh water to prevent them from becoming clogged with salt deposits.

3. Maintenance

While using the outboard motor, the periodic maintenance is necessary for you to ensure its performance.

⚠ WARNING:

Be sure to turn off the engine when you perform maintenance unless otherwise specified. If you or the owner is not familiar with machine servicing, this work should be done by your PARSUN dealer or other qualified mechanic.

CAUTION:

If replacement parts are necessary, use only genuine PARSUN parts or parts of the same type and of equivalent strength and materials.

3.1 Greasing

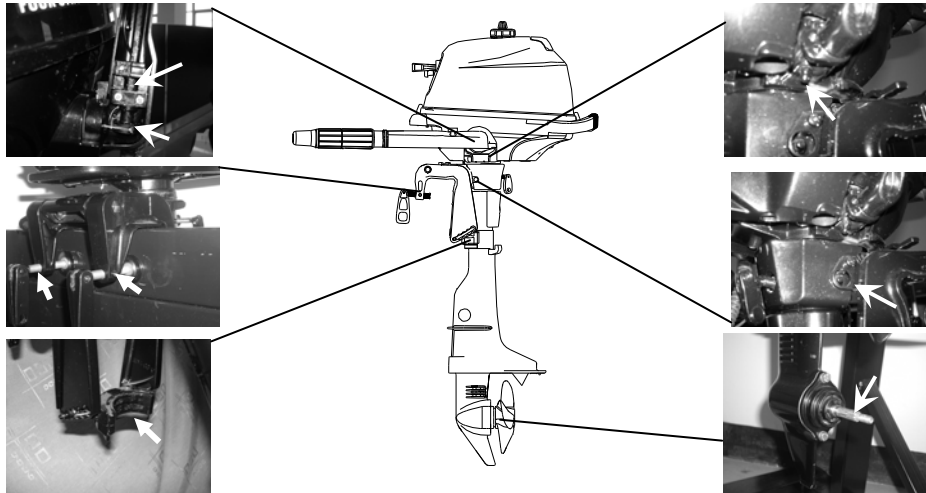

3.2 Cleaning and adjusting spark plug

You should periodically remove and inspect the spark plug because heat and deposits will cause the spark plug to slowly break down and erode. If necessary, you should replace the spark plug with another of the correct type.

Before fitting the spark plug, measure the electrode gap with a wire thickness gauge. adjust the gap to specification if necessary.

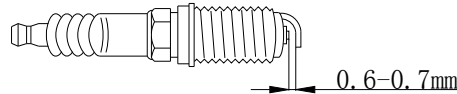

When fitting the plug, always clean the gasket surface and use a new gasket. Wipe off any dirt from the threads and screw in the spark plug to the correct torque.

3.3 Checking the fuel system

1. Check the fuel lines for leaks, crack, or malfunction. If a problem is found, your PARSUN dealer or other qualified mechanic should repair it immediately.

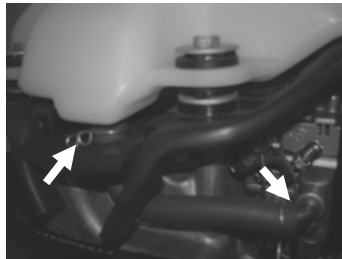

 **WARNING:**

- Check for fuel leakage regularly.
- If any fuel leakage is found, the fuel system must be repaired by a qualified mechanic.

3.4 Inspecting idling speed

A diagnostic tachometer should be used for this procedure. Results may vary depending on whether testing is conducted with the flushing attachment, in a test tank, or with the outboard motor in the water.

1. Start the engine and allow it to warm up fully in neutral until it is running smoothly.
2. Verify whether the idle speed is set to specification.

Idle speed: 1900±100Rpm

CAUTION:

Correct idling speed inspection is only possible if the engine is fully warmed up. If not warmed up fully, the idle speed will measure higher than normal. If you have difficulty verifying the idle speed, or the idle speed requires adjustment, consult a PARSUN dealer or other qualified mechanic.

3.5 Changing engine oil

 **WARNING:**

- Avoid draining the engine oil immediately after stopping the engine. The oil is hot and should be handled with care to avoid burns.
- Be sure the outboard motor is securely fastened to the transom or a stable stand.

CAUTION:

Change the engine oil after the first 10 hours of operation, and every 100 hours or at 6-month intervals thereafter. Otherwise the engine will wear quickly. Change the engine oil when the oil is still warm.

1. Put the outboard motor in an upright position (not tilted).

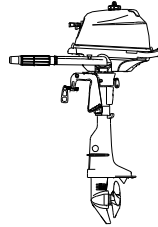

2. Prepare a suitable container that holds a larger amount than the engine oil capacity. Loosen and remove the drain screw while holding the container under the drain hole. Then remove the oil filler cap. Let oil drain completely. Wipe up any spilled oil immediately.

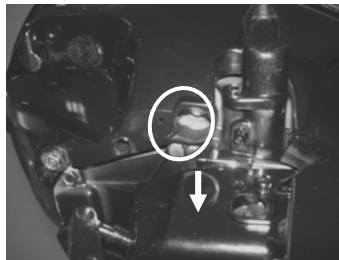

3. Put a new gasket on the oil drain screw. Tighten the drain screw.
4. Add the correct amount of oil through the filler hole. Install the filler cap.
5. Start the engine and make sure that there are no oil leaks.
6. Turn off the engine and wait 3 minutes. Recheck the oil level using oil level check window to be sure the level falls between the upper and lower marks.

CAUTION:

The oil should be changed more often when the engine is operated under adverse conditions such as extended trolling.

3.6 Checking wiring and connectors

Check that each grounding wire is properly secured and each connector is engaged securely.

3.7 Checking for leakage

Check that no exhaust or water leaks from the joints between the exhaust cover, cylinder head, and body cylinder. Check for oil leaks on the around the engine.

CAUTION:

If any leaks are found, consult your PARSUN dealer.

3.8 Checking propeller

⚠ WARNING:

- Before inspecting, removing or installing the propeller, always take actions to ensure the engine will not accidentally start, such as removing the spark plug caps from the spark plugs, placing the shift control in neutral, and removing the lanyard from the engine stop switch, etc.. Serious accident could occur if the engine starts when you are nearby.
- Do not use your hand to hold the propeller when loosening or tightening the propeller nut.. Put a wood block between the anti-cavitation plate and the propeller to prevent the propeller from turning.

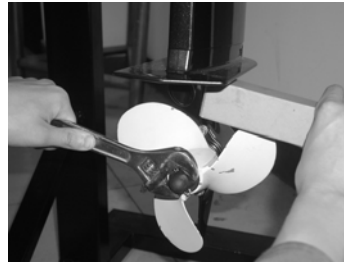

1. Check each of the propeller blades for wear, erosion from cavitation or ventilation, or other damage.
2. Check the propeller shaft for damage.
3. Check the splines/shear pin for wear or damage.
4. Check for fish line tangled around the propeller shaft.

5. Check for the propeller shaft oil seal for damage.

3.8.1 Removing the propeller

1. Straighten the cotter pin and pull it out using a pair of pliers.
2. Remove the propeller nut, washer, and spacer (if equipped).
3. Remove the propeller and thrust washer.

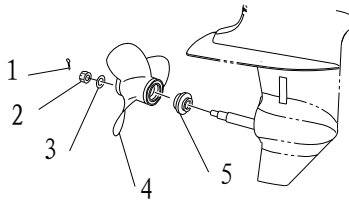

1. Cotter pin
2. Propeller nut
3. Washer
4. Propeller
5. Thrust washer

3.8.2 Installing the propeller

CAUTION:

- Be sure to install the thrust washer before installing the propeller, otherwise the lower case and propeller boss could be damaged.
 - Be sure to use a new cotter pin and bend the ends over securely. Otherwise the propeller could come off during operation and be lost.
1. Apply a marine grease or corrosion resistant grease to the propeller shaft.
 2. Install the spacer (if equipped), thrust washer, and propeller on the propeller shaft.
 3. Install the spacer (if equipped) and the washer.

4. Tighten the propeller nut. Align the propeller nut with the propeller shaft hole.
Insert a new cotter pin in the hole and bend the cotter pin ends.

3.9 Changing gear oil

WARNING:

- Be sure the outboard motor is securely fastened to the transom or a stable stand.
 - Never get under the lower unit while the outboard motor is tilted, even when the tilt support lever or knob is locked. Serious injury could occur if the motor falls.
1. Tilt the outboard motor so that the gear oil drain screw is at the lowest point possible.
 2. Place a suitable container under the gear case.
 3. Remove gear oil drain screw.

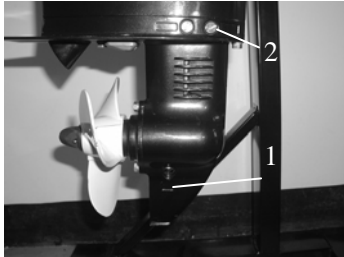

- 1 . Gear oil drain screw
- 2 . Oil level plug

CAUTION:

Change the gear oil after the first 10 hours of operation, and every 100 hours or at 6-month intervals thereafter. Otherwise the gear will wear quickly.

4. Remove the oil level plug to allow the oil to drain completely.

CAUTION:

Inspect the used oil after it has been drained. If the oil is milky, water is getting into the gear case which can cause gear damage. Consult PARSUN dealer.

5. Use a flexible or pressurized filling device, inject the gear oil into the gear oil drain screw hole.

6. When the oil begins to flow out of the oil level plug hole, insert and tighten the oil level plug (If necessary, change the seal spacer).

7. Insert and tighten the gear oil drain screw (If necessary, change the seal spacer).

3.10 Cleaning fuel tank

 **WARNING:**

- **Keep away from sparks, cigarettes, flames, or other sources of ignition when cleaning the fuel tank.**

- **Cleaning the fuel tank in a well-ventilated open air.**

1. Empty the fuel tank into an approved container.

2. Pour a small amount of suitable solvent into the tank. Install the cap and shake the tank. Drain the solvent completely.

3. Pull the fuel joint assembly out of the tank.

4. Clean the filter in a suitable cleaning solvent and allow it to dry.

5. Replace the gasket with a new one. Reinstall the fuel joint assembly and tighten the screws firmly.

3.11 Checking and replacing anode(s)

Inspect the external anodes periodically. Remove scales from the surfaces of the anodes. Consult a PARSUN dealer for replacement of external anodes.

CAUTION:

Do not paint anodes, as this would render them ineffective and can cause more rapid engine corrosion.



3.12 Checking top cowling

Check the fitting of the top cowling by pushing it with both hands. If it is loose have it repaired by your PARSUN dealer.



3.13 Maintenance Table

When utilized under normal condition, maintained and repaired in the proper manner, the motor can work normally within the normal life period.

Frequency of maintenance operations may be adjusted according to the operating conditions, but the following table gives general guidelines.

The “●” symbol indicates the check-ups which you may carry out by yourself.

The “○” symbol indicates work to be carried out by your Parsun dealer.

Item	Operations	Initial		Every	
		10 hours (1 month)	50 hours (3 months)	100 hours (6 months)	200 hours (1 year)
Anode(s) (external)	Check/replacement		●/○	●/○	
Anode(s) (internal)	Check/replacement				○
Cooling water passages	Cleaning		●	●	
Cowling clamp	Check				●
Fuel filter (disposable)	Check/cleaning	●	●	●	
Fuel system	Check	●	●	●	
Fuel tank (portable tank)	Check/cleaning				●
Gear oil	Change	●		●	
Greasing points	Greasing			●	
Idling speed (carburetor models)	Check/adjustment	●/○		●/○	
Propeller and cotter pin	Check/replacement		●	●	
Shift link/shift cable	Check/adjustment				○

Continuation /...1

Item	Operations	Initial		Every	
		10 hours (1 month)	50 hours (3 months)	100 hours (6 months)	200 hours (1 year)
Thermostat	Check				○
Throttle link/throttle cable/Throttle pick-up timing	Check/ adjustment				○
Water pump	Check				○
Engine oil	Check/ replacement	●		●	
Oil filter	Change				○
Spark plug (s)	Cleaning/ adjustment/ replacement	●			●
Timing belt	Check/replacement			○	○
Valve clearance (OHC,OHV)	Check/adjustment	○		○	

NOTE:

When operating in salt water, turbid or muddy water, the engine should be flushed with clean water after every use.

4 Transporting and storing

4.1 Transporting

The outboard motor should be trailed and stored in the normal running position. If there is insufficient road clearance in this position, then trailer the outboard motor in the tilt position using a motor support device.

CAUTION:

Do not use the tilt support lever or knob when trailering the boat. The outboard motor could shake loose from the tilt support and fall.

! WARNING:

- Never get under the lower unit while it is tilted, even if a motor support bar is used.
- When transporting or storing the outboard motor while removed from a boat, keep the outboard motor in the attitude shown.

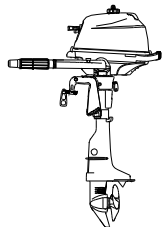

figure 1

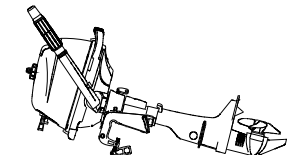

figure 2

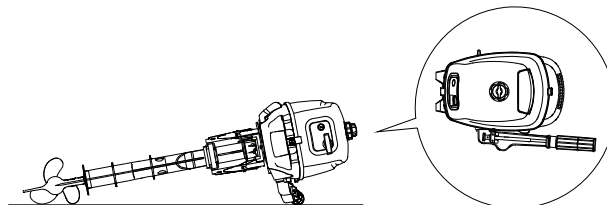

figure 3

Note:

- Place a towel or something similar under the outboard motor to protect it from damage when as shown in the figure 2 or figure 3 above.
- Please make sure the tiller handle faces down to make the throttle handle point to the direction of propeller.

4.2 Storing

When storing your PARSUN outboard motor for prolonged periods of time (2 months or longer), several important procedures must be performed to prevent excessive damage. It is advisable to have your outboard motor serviced by an authorized PARSUN dealer prior to storage. However, you, the owner, with a minimum of tools, can perform the following procedures.

CAUTION:

- **Keep the outboard motor in an upright attitude when transporting and storing it. If storing or transporting the outboard motor on its side (not upright), put it on a cushion after draining the engine oil completely.**
 - **Do not place the outboard motor on its side before the cooling water has drained from it completely.**
 - **Store the outboard motor in a dry, well-ventilated place, not in direct sunlight.**
1. Wash the outboard motor body using fresh water.
 2. Place the fuel cock in the closed position, disconnect the fuel line and tighten the air vent screw, if equipped.
 3. Remove the engine top cowling and silencer cover.
 4. Install the outboard motor on the test tank.

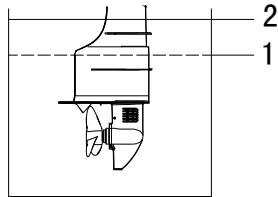

1. Lowest water level
2. Water surface

5. Fill the tank with fresh water to above the level of the anti-cavitation plate.

CAUTION:

If the fresh water level is below the level of the anti-cavitation plate, or if the water supply is insufficient, engine seizure may occur.

6. Start the engine. Flush the cooling system. Perform the flushing and fogging at the same time, as fogging/lubricating of the engine is mandatory to prevent engine rust.



WARNING:

- **Do not touch or remove electrical parts when starting or during the operation.**
 - **Keep hands, hair, and clothes away from the flywheel and other rotating parts while the engine is running.**
7. Run the engine at a fast idle for a few minutes in neutral position.
8. Just prior to turning off the engine, quickly spray “Fogging Oil” alternately into each carburetor or the fogging hole of the silencer cover, if equipped.
9. If “Fogging Oil” is not available, run the engine at a fast idle until the fuel system empties and the engine stops.
10. If “Fogging Oil” is not available, remove the spark plug(s). Pour a teaspoonful of clean engine oil into each cylinder. Crank several times manually. Replace the spark plug(s).
11. Drain the fuel from the fuel tank completely.

5 Actions in emergency

5.1 Impact damage

If the outboard motor hits an object in the water, follow the procedure below.

1. Stop the engine immediately.
2. Inspect the control system and all components for damage.
3. Whether damage is found or not, return to the nearest harbor slowly and carefully.
4. Have a PARSUN dealer inspect the outboard motor before operating it again.

5.2 Starter will not operate

If the starter mechanism does not operate, the engine can be started with an emergency starter rope.



WARNING:

- Use this procedure only in an emergency and only to return to port for repairs.
- Be sure no one is standing behind you when pulling the starter rope. It could whip behind you and injure someone.
- Do not install the starter mechanism or top cowling after engine is running.
- Keep loose clothing and other objects away when starting the engine. Do not touch the flywheel or other moving parts when the engine is running.
- Do not touch the ignition coil, spark plug wire, spark plug cap, or other electrical components when starting or operating the motor.

The procedure is as follows:

1. Remove the top cowling.
2. Remove the fuel tank bolts.

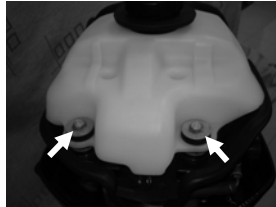

3. While lifting the fuel tank up, remove the bolt from the starter case.



4. While lifting the starter case up, disconnect the choke wire from the carburetor.



5. Remove the starter case.
6. Install the fuel flywheel case by installing the bolts.



7. Install 2 bolts into the rear section of the fuel tank.

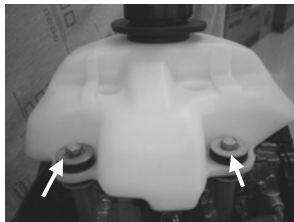

8. Prepare the engine for starting. For further information, see section 2.5.

9. Turn the lever on the carburetor to operate the choke system when the engine is cold. After the engine starts, return the lever to the original position.



10. Insert the knotted end of the emergency starter rope into the notch in the flywheel rotor and wind the rope several turns around the flywheel clockwise.
11. Pull the rope slowly until resistance is felt.

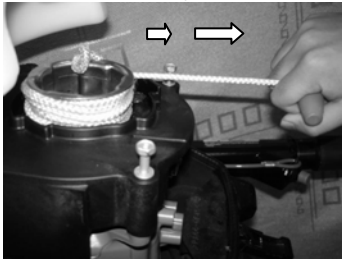

12. Give a strong pull straight out to crank and start the engine. Repeat it necessary.

5.3 Treatment of submerged motor

If the outboard is submerged, immediately take it to a PARSUN dealer. Otherwise some corrosion may begin almost immediately.

1. Thoroughly wash away contaminants with fresh water.
2. Remove the spark plug(s), then face the spark plug hole downward to allow any mud, or contaminants to drain.
3. Drain the fuel from the carburetor, fuel filter, and fuel line. Drain the engine oil completely.

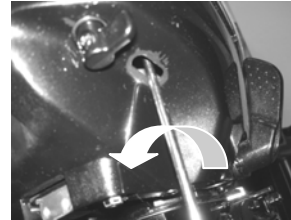

4. Fill the sump with fresh engine oil.
5. Feed engine fogging oil or engine oil through the carburetor(s) and spark plug holes while starting the engine.



6. Take the outboard motor to a PARSUN dealer as soon as possible.

CAUTION:

Do not attempt to run the outboard motor until it has been completely inspected.

6. Troubleshooting

Trouble type	Possible reason	Recovery action
Starter will not operate	Starter components are faulty	Have serviced by your dealer
	Shift level is not in neutral	Shift to neutral
Engine will not start (starter operates)	Fuel tank is empty	Fill tank with clean, fresh fuel
	Fuel is contaminated or stale	Fill tank with clean, fresh fuel
	Spark plug(s) fouled or of incorrect type	Inspect spark plug(s). Clean or replace with recommended type
	Spark plug cap(s) fitted incorrectly	Check and re-fit cap(s)
	Ignition wiring damaged or poorly connected	Check wires for wear or breaks. Tighten all loose connections. Replace worn or broken wires
	Ignition parts are faulty	Have serviced by your dealer
	Engine stop switch lanyard is not attached	Attach lanyard
	Engine inner parts are damaged	Have serviced by your dealer
Engine idles irregularly or stalls	Spark plug(s) fouled or of incorrect type.	Inspect spark plug(s). Clean or replace with recommended type
	Fuel system is obstructed	Check for pinched or kinked fuel line or other obstructions in fuel system
	Fuel is contaminated or stale	Fill tank with clean, fresh fuel

Continuation /...1

Trouble type	Possible reason	Recovery action
Engine idles irregularly or stalls	Spark plug gap is incorrect	Inspect and adjust as specified
	Ignition wiring damaged or poorly connected	Check wires for wear or breaks. Tighten all loose connections. Replace worn or broken wires
	Specified engine oil is not being used	Check and replace oil as specified
	Thermostat is faulty or clogged	Have serviced by your dealer
	Carburetor adjustments are incorrect	Have serviced by your dealer
	Carburetor is clogged	Have serviced by your dealer
	Air vent screw on fuel tank is closed	Open air vent screw
	Throttle valve adjustment is incorrect	Have serviced by your dealer
	Choke knob is pulled out	Return to home position
	Motor angle is too high	Return to normal operating position
Engine power loss	Propeller is damaged	Repair or replace propeller
	Trim angle is incorrect	Adjust trim angle to achieve most efficient operation
	Motor is mounted at incorrect transom height	Adjust motor to proper transom height
	Boat bottom is fouled with marine growth	Clean boat bottom

Continuation /...2

Trouble type	Possible reason	Recovery action
Engine power loss	Weeds or other foreign matter are tangled on gear housing	Remove foreign matter and clean lower unit
	Spark plug(s) are fouled or incorrect type	Inspect spark plug(s). Clean or replace with recommended type
	Fuel system is obstructed	Check for pinched or kinked fuel line or other obstructions in fuel system
	Fuel filter is clogged	Replace with recommended type
	Fuel is contaminated or stale	Fill tank with clean, fresh fuel
	Spark plug gap is incorrect	Inspect and adjust as specified
	Ignition wiring is damaged or poorly connected	Check wires for wear or breaks. Tighten all loose connections. Replace worn or broken wires
	Ignition parts have failed	Have serviced by your dealer
	Specified engine oil is not being used	Check and replace oil as specified
	Thermostat is faulty or clogged	Have serviced by your dealer
	Air vent screw on fuel tank is closed	Open air vent screw
	Specified spark plug(s) are not being used	Check and replace spark plug(s) as specified

Continuation /...3

Trouble type	Possible reason	Recovery action
Engine vibrates excessively	Propeller is damaged	Repair or replace propeller
	Propeller shaft is damaged	Have serviced by your dealer
	Weeds or other foreign matter are tangled on propeller	Remove and clean propeller
	Motor mounting bolt is loose	Tighten bolt
	Steering pivot is loose	Tighten it
	Steering pivot is damaged	Have serviced by your dealer

7. Circuit diagram

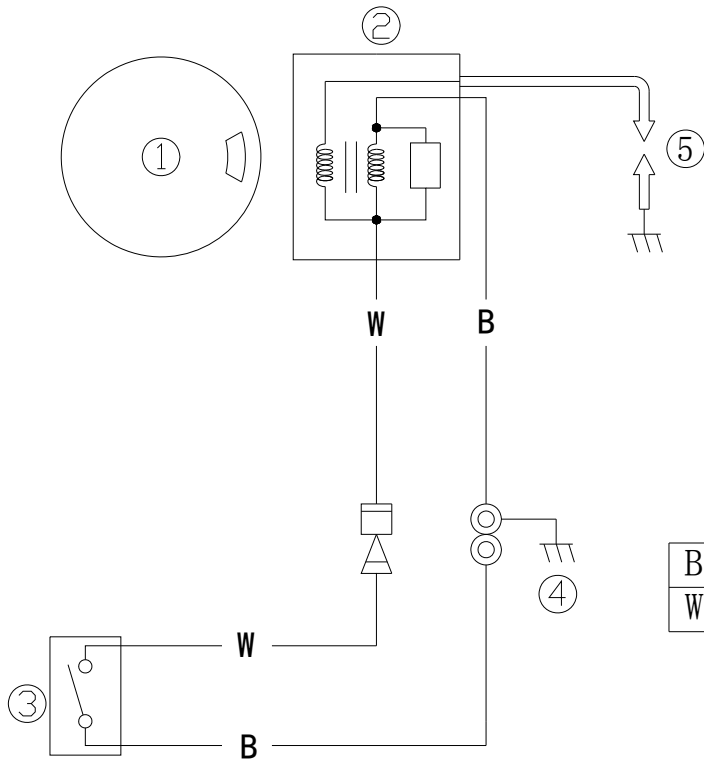

5	Spark plug
4	Earthing
3	Engine stop switch
2	Ignitor ass'y
B	black
1	Magnet flywheel
W	white
SN.	DESCRIPTION